

Engaging with the Water Framework Directive

Guidance for Local Authorities



Engaging with the Water Framework Directive

Contents

1.0	Introduction	6
2.0	What is the Water Framework Directive?	6
2.1	The Directive	6
2.2	Requirement for achieving “good” status	6
2.3	Assessment of water body status	8
2.4	Overarching aims of the WFD	8
2.5	Implementation	8
2.6	Further information	8
3.0	Local Authorities and the Water Framework Directive	9
3.1	Local authority statutory responsibilities under WFD	9
3.2	How can local authorities contribute to WFD objectives?	10
3.3	Integrated Pollution Prevention and Control	11
4.0	What do we mean by a Catchment Based Approach?	11
4.1	What is a river catchment?	11
4.2	Why this approach?	12
4.3	Objectives of the catchment based approach	12
4.4	What about catchment partnerships?	13
4.5	Further Information	13
5.0	Guidance for Planners	14
5.1	The Water Framework Directive and Planning	15
	5.1.1 Legislation	15
	5.1.2 Policy	17
	5.1.3 What if WFD requirements are not met?	19
5.2	How Might Development Impact on the Water Environment?	19
	5.2.1 Causes of poor water body status	19
	5.2.2 Improvements to the water environment which can contribute to positive WFD outcomes	20
5.3	Measuring Water Quality Under the WFD	21
	5.3.1 Overall Water Body Status	21
	5.3.2 Consulting the experts for detailed assessment	22
	5.3.3 WFD Assessment	22
5.4	How Planners Can Contribute to WFD Targets	23

5.4.1	How can planners contribute to WFD targets in relation to the five key WFD measures?	23
5.4.2	How can planning policies contribute to WFD objectives?	25
5.4.3	Case studies	26
5.4.4	Lessons learned	26
6.0	Guidance for Highways Departments	27
6.1	Examples of good practice in local authority highways functions to protect the water environment and provide WFD benefits	27
6.1.1	Assessment of pollution and flood risk from new and existing road networks	27
6.1.2	Road design	28
6.1.3	Other considerations	28
6.2	The benefits of SuDS	28
6.2.1	Flood risk management – reducing the risk of flooding from roads	28
6.2.2	Water quality management	29
6.3.3	Amenity and biodiversity benefits	31
6.4	Highways SuDS Design	31
6.5	Highways and street maintenance	32
6.6	Rural Roads – case study	32
6.7	Accidental spillages and incident response	33
7.0	Guidance for Greenspace Departments	34
7.1	Green infrastructure networks can be used to reduce surface water run-off, store flood water and improve water quality	34
7.2	Planning green and blue Infrastructure	35
7.2.1	Regional or catchment scale	35
7.2.2	Town or city scale	35
7.2.3	Site scale	35
7.3	Multifunctional value of green space	35
7.4	Managing green spaces	36
7.4.1	Managing the waterbody	36
7.4.2	Managing the management of the site	36
7.4.3	Managing the infrastructure	37
7.4.4	Wider working	37

8.0	Working in Partnership	38
9.0	Useful Links	39
9.1	Rivers and Catchments	39
9.2	Legislation and Policy	39
9.3	Sustainable Drainage	40
9.4	Planning and WFD	41
9.5	River Restoration	41
9.6	Highways	42
	Appendices	43
	Appendix A – Case Studies	43
	Appendix B – WFDa Validation Checklist	54

Foreword

As Local Authority Officers, you have the opportunity to play a key role in delivering a high quality water environment.

We need to “use water more efficiently and raise awareness of the connection between our water use and the quality of our rivers and the ecosystems they support”.

Government Water White Paper – Water for Life (December 2011)



Water, and indeed high quality water, is vital to life. However the real challenge both now and for the future is in managing the balance between having too much water or, on the flip side, having too little. Effective management of this critical resource can deliver opportunities to improve the quality of our water in both urban and rural environments, helping ecosystems to flourish and communities to prosper.

Ensuring a sustainable approach to managing the water environment must be at the forefront of decision making across all local authority departments – this is not only linked to statutory duties, but moreover it is clearly a common sense approach.

Acknowledgements

This publication was produced via a partnership project between Dorset Wildlife Trust and Nottinghamshire Wildlife Trust, and made possible through Environment Agency Catchment Partnership Funding. We are grateful to many individuals within RTPI East Midlands, Nottingham City Council, Severn Trent Water, The Rivers Trust, Leicester City Council, Buckinghamshire County Council, and Dorset County Council for their time, commitment and valuable input to the project.

1.0 Introduction

Local authorities have statutory duties to deliver Water Framework Directive (WFD) objectives and this resource aims to provide information on how this can be achieved. It gives an introduction to the WFD and the concept of working within a Catchment Based Approach to achieve positive outcomes for the environment.

A high quality water environment is important for local economies and communities because it:

- provides water for households, businesses, industry, food production and agriculture;
- provides habitat and water for wildlife;
- enhances the attractiveness of areas to people and investment;
- provides a recreational resource, quality of life and health benefits;
- provides water to help dilute treated wastewater; and
- supports our resilience to predicted climate change by providing watercourses, flood plains and green space to reduce flood risk and excessive summer heat in urban areas.

Local Authority Services and the Water Environment Executive Summary
(Environment Agency, 2012)

NB. Links to all of the documents referred to in the guidance are provided in Section 9.0 - Useful Links.

2.0 What is the Water Framework Directive?

2.1 The Directive

Directive 2000/60/EC – the Water Framework Directive (WFD) is a European Directive which came into effect in 2003, establishing a legal framework for the protection and promotion of sustainable water management of surface waters (including coastal waters out to one nautical mile) and groundwater.

2.2 Requirement for achieving “good” status

The WFD requires all inland and coastal waters to achieve “good” status through a catchment-based system of River Basin Management Plans (RBMPs) which describe the quality of water bodies, the pressures they face and the actions needed to meet WFD objectives of ‘good’ water body status. There are 11 river basin districts in England and Wales as illustrated on Figure 1 below. Each of these districts has its own RBMP, with objectives and priorities enabling a geo-specific focus on the protection, improvement and sustainable use of the water environment. River basin management is a continuous process of planning and delivery and the WFD uses a series of 6 year cycles. RBMPs are prepared to ensure a consistent approach to managing the water environment throughout the European Union, whereby each country has to:

- Prevent deterioration in the status of aquatic ecosystems, protect them and improve the ecological condition of waters;
- Aim to achieve at least good status for all water bodies by 2015. Where this is not possible and subject to the criteria set out in the Directive, aim to achieve good status by 2021 or 2027;
- Meet the requirements of Water Framework Directive Protected Areas;
- Promote sustainable use of water as a natural resource;
- Conserve habitats and species that depend directly on water;
- Progressively reduce or phase out the release of individual pollutants or groups of pollutants that present a significant threat to the aquatic environment;
- Progressively reduce the pollution of groundwater and prevent or limit the entry of pollutants;
- Contribute to mitigating the effects of floods and droughts.

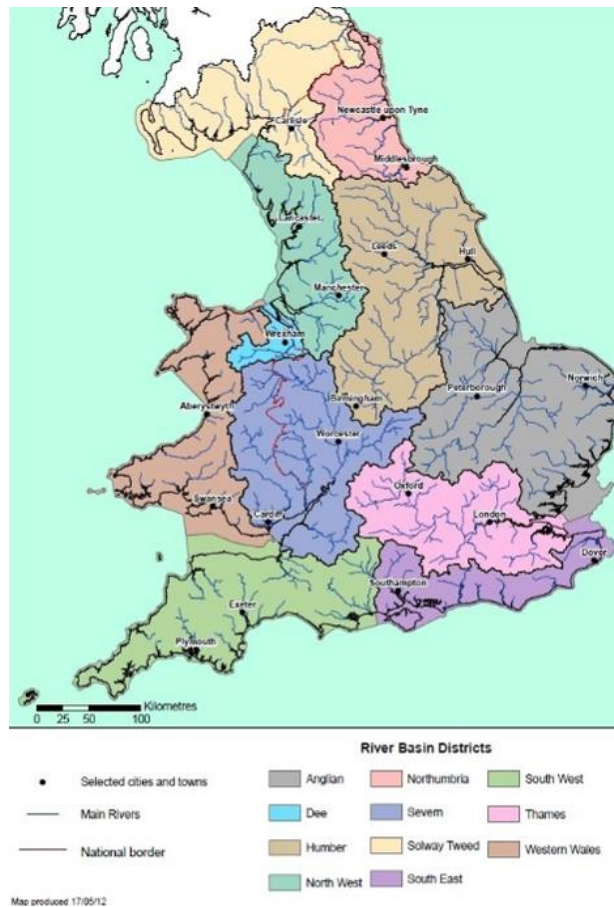

Source: Environment Agency, 2012

Figure 1: River Basin Districts in England and Wales

2.3 Assessment of water body status

The overall status of each water body is assessed as a combination of ecological status and chemical status (see Figure 2). The ecological status has a scale of high, good, moderate, poor and bad, while good chemical status means achieving the required standards for relevant substances. For a water body to be in overall 'good' status, both its ecological and its chemical status must be at least 'good'.

What is a Water Body?

A Water Body means a discrete and significant element of surface water such as a lake, reservoir, stream, river or canal, part of a stream, river or canal, or a stretch of coastal water; or a distinct volume of groundwater within an aquifer.

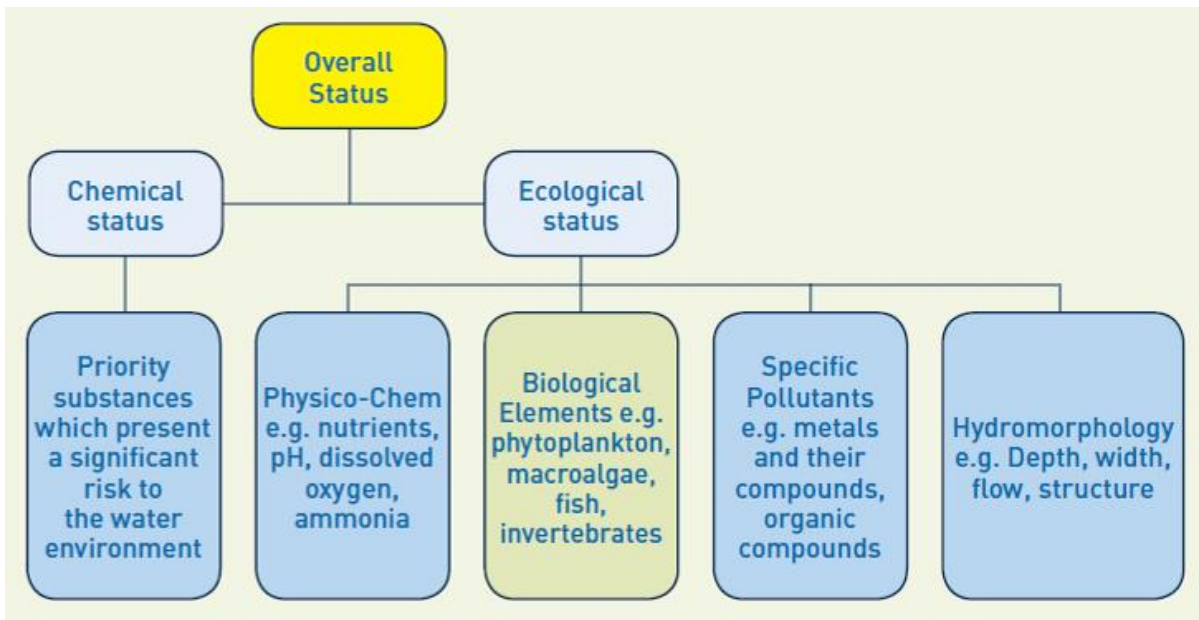

Source: Environment Agency, 2012

Figure 2: Breakdown of Water Body Status

2.4 Overarching aims of the WFD:

- Prevent deterioration in water body status
- Reduce water pollution
- Conserve aquatic ecosystems and habitats
- Reduce the effects of floods and droughts on water bodies
- Promote sustainable use of water as a natural resource

2.5 Implementation

The WFD is implemented in England and Wales through The Water Environment (Water Framework Directive) (England and Wales) Regulations 2003.

2.6 Further information

You can find the full text of the WFD here:

<http://eur-lex.europa.eu/legal-content/EN/TXT/HTML/?uri=CELEX:32000L0060&from=EN>

You can find the full text of the Water Environment Regulations here:

<http://www.legislation.gov.uk/ukxi/2003/3242/contents/made>

How to find out the status of a water body

Visit the Environment Agency's Catchment Data Explorer website

<http://environment.data.gov.uk/catchment-planning/>

Catchment Data Explorer BETA

Home Useful Links Help Glossary Contact us

Environment Agency

Use the catchment data explorer to navigate to catchments and water bodies, view catchment summaries and download data. This site supports the consultation on the updates to the river basin management plans. You can get involved here. [Show more >](#)

Search by: Place name:

River Basin Districts

To get started select a River Basin District on the map or use the searches above.

Anglian River Basin District
Dee River Basin District
Humber River Basin District
North West River Basin District
Northumbria River Basin District
Severn River Basin District
Solway Tweed River Basin District
South East River Basin District
South West River Basin District
Thames River Basin District

3.0 Local Authorities and the Water Framework Directive

3.1 Local authority statutory responsibilities under WFD

- ✓ Duty to have regard to River Basin Management Plans and supplementary plans

Regulation 17 of the Water Environment Regulations states that, like other public bodies, local authorities must “*have regard to the River Basin Management Plan for that district*” and “*any supplementary plans*” in exercising their functions. Essentially, they must reflect water body improvement priorities as outlined in RBMPs – this could be through local planning policies, green infrastructure plans or planning applications.

- ✓ Provision of information and assistance

Regulation 19 of the same Regulations requires local authorities to provide “*such information in its possession*” and “*such assistance as the Environment Agency may reasonably seek*” in connection with its WFD functions. Incorporation of WFD objectives into all aspects of local authority function may therefore be seen to be necessary to meet this requirement.

3.2 How can local authorities contribute to WFD objectives?

Local authorities can help to address the causes of poor water body status and make a major contribution to meeting WFD objectives, both in their own activities and in their work with others. Key local authority functions which can contribute to WFD objectives include:

1. **Local planning policies** which protect and enhance the water environment, including incorporating WFD priorities into Local Plans and Infrastructure Delivery Plans, plus local authority engagement in the preparation of River Basin Management Plans.
2. **Development management and building control** functions – determining planning applications to secure benefits for the water environment through sustainable drainage, water efficiency, habitat improvements and avoidance of drainage ‘misconnections’ and to prevent damage to the water environment.
3. **Drainage, flood risk management and SuDS** – securing water quality and water environment improvements through flood management, drainage and sustainable drainage systems (SuDS) functions, including the forthcoming local authority SuDS Approval Body (SAB) roles.
4. **Environmental health and pollution control** functions, such as engaging with businesses to reduce water pollution and raising public awareness of drainage misconnections.
5. Managing a **local authority’s own buildings, assets and greenspace**, including council owned housing, industrial estates and green space, to reduce polluting runoff, improve water body habitats and promote water efficiency.
6. Local authority **highways** functions – highways design, use of SuDS, highways maintenance and street cleansing to reduce pollution and flood risk from highways run-off.
7. Local authority **community leadership, advocacy and partnership** roles, encouraging and working with others (including residents, community groups, businesses, land owners, Local Enterprise Partnerships and public sector bodies) to protect and enhance the water environment.”

Source: Local Authority Services and the Water Environment Executive Summary (Environment Agency, 2012)

3.3 Integrated Pollution Prevention and Control

Pollution from larger industrial installations is regulated under the Pollution Prevention and Control regime. This regime implements the EU Directive on Integrated Pollution Prevention and Control (IPPC) (2008/1/EC). IPPC applies an integrated environmental approach to the regulation of certain industrial activities, for example those which may lead to emission of pollutants to air, water or land, and requires such installations to have a permit containing emission limit values.

The IPPC permit process is delivered by local authorities who must consider applications and carry out consultation with relevant organisations and members of the public before deciding on whether approval can be given. If the local authority decides to issue a permit, it must include permissions to set out how pollution will be minimised.

WFD status should be a key consideration in the IPPC process where an installation may impact on the water environment

4.0 What do we mean by a Catchment Based Approach?

4.1 What is a river catchment?

A catchment is a geographic area defined naturally by surface water hydrology. The water environment is affected by every activity that takes place on land as well as through our actions in abstracting, using and returning water to rivers, the sea and the ground. Catchments (see Figure 3) are the natural scale to consider this aspect of the environment.

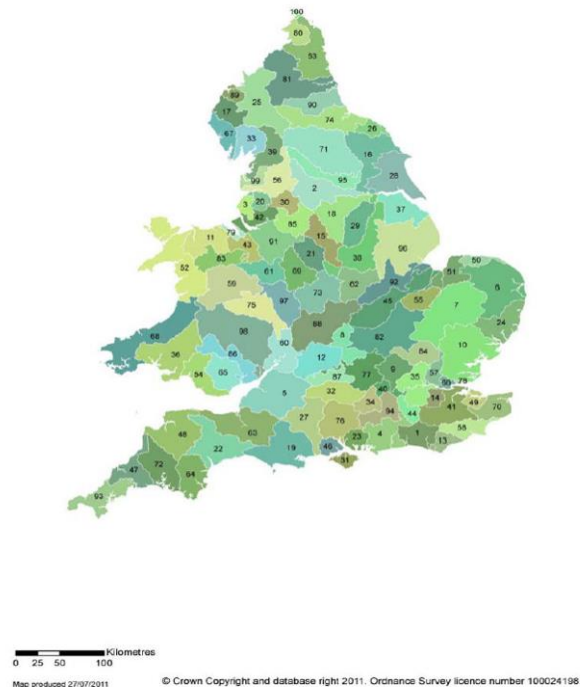

Source: DEFRA, 2013

Figure 3: Water Framework Directive Management Catchments

4.2 Why this approach?

A catchment-based approach to managing the water environment looks at activities and issues in the catchment as a whole, rather than considering different aspects separately in different locations. Crucially, this approach involves bringing people together from different sectors to identify issues and agree priorities for action – and ultimately building local partnerships to put these actions in place.

Source: Catchment Change Management Hub <http://ccmhub.net/the-catchment-approach/what-is-catchment-management/>

Figure 4 below illustrates just some of the activities which can impact the water environment at a catchment scale. The catchment based approach ensures that all sectors are involved, including industry, agriculture and water companies for example.



Figure 4: Some of the activities which impact the water environment

4.3 Objectives of the catchment based approach

- To deliver positive and sustained outcomes for the water environment by promoting a better understanding of the environment at a local level
- To encourage local collaboration and more transparent decision-making when both planning and delivering activities to improve the water environment

4.4 What about catchment partnerships?

Working at the catchment level, these partnerships are groups that work with key stakeholders to agree and deliver the strategic priorities for the catchment and to support the Environment Agency in developing appropriate River Basin Management Plans, required under the Water Framework Directive.

4.5 Further Information

For more information on the Catchment Based Approach, see the following guidance from DEFRA:

Catchment Based Approach: Improving the quality of our water environment.

Available at:

https://www.gov.uk/government/uploads/system/uploads/attachment_data/file/204231/pb13934-water-environment-catchment-based-approach.pdf

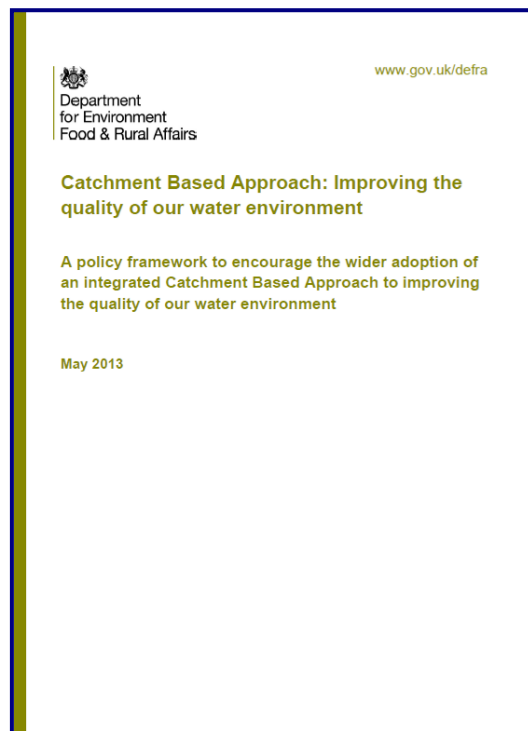

The Catchment Based Approach website also contains a wealth of useful information and can help to identify local contacts – see <http://www.catchmentbasedapproach.org/>

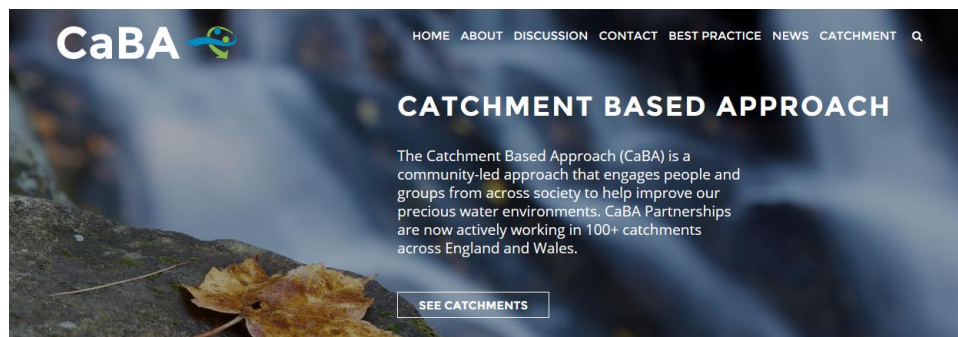

5.0 Guidance for Planners

The Water Framework Directive integrates the water environment, including water quality, flood risk, biodiversity and water resourcing.



Figure 5: Integration of the water environment under WFD

This guidance aims to give planners an understanding of their duties under the Water Framework Directive and how its objectives can be delivered through the planning system.

The information below considers the policy and legislative drivers which need to be considered, key issues and some possible solutions, as well as a number of case studies to highlight good and bad practice.

A 'Training Pack for Planners and Developers' is available which summarises this information into a downloadable document. This can be delivered through two presentations and an interactive session which considers 'model' development scenarios.

For more information and to download the documents, visit the CaBA website at: <http://www.catchmentbasedapproach.org/best-practice/build/laquidance>

5.1 The Water Framework Directive and Planning

5.1.1 Legislation

Directive 2000/90/EC (the Water Framework Directive, or WFD) is a European Directive which requires that the inland and coastal waters of all member states reach 'good' status through a catchment based system of River Basin Management Plans. These plans contain the main issues for the water environment and information on what is needed to tackle these issues.

In legal terms, the WFD is a material consideration in the planning process

As previously raised in Section 2.5, the WFD is implemented in England and Wales through [The Water Environment \(Water Framework Directive\) \(England and Wales\) Regulations 2003](#) which requires that *'each public body must, in exercising their functions so far as affecting a river basin district, have regard to the river basin management plan for that district'*.

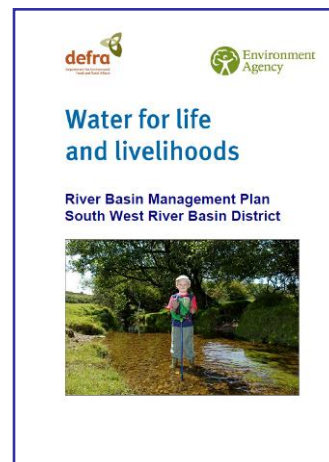
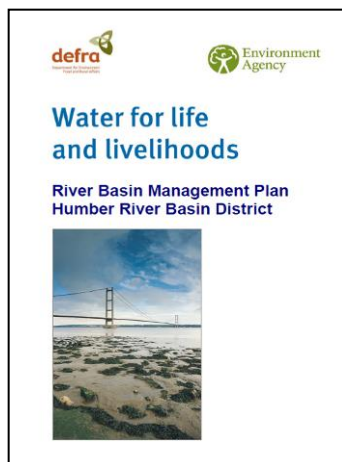

Under the WFD, the overall status of each water body is assessed as a combination of **ecological status** and **chemical status**. For a water body to be in overall 'good' status, **both** its ecological and its chemical status must be at least 'good'.

Ecological considerations are key to the overall assessment of each water body and the planning system has a major part to play in delivering the required 'good' status.

From this....



To this....



Ecology and biodiversity are inextricably intertwined and the WFD therefore also links to the **duty of planners under the Natural Environment and Rural Communities Act 2006**. This states that *'every public body must, in exercising its functions, have regard, so far as is consistent with the proper exercise of those functions, to the purpose of conserving biodiversity'*.

What if you had helped to plan this?



Further **material considerations** in the form of legislation which is of direct relevance to biodiversity conservation include (but are not limited to):

- Convention on Biological Diversity 1992
- Council Directive of the Conservation of Wild Birds 1979

- Council Directive on the Conservation of Natural Habitats and of Wild Fauna and Flora 1992
- Wildlife and Countryside Act 1981 (as amended)
- Environmental Protection Act 1990
- Land Drainage Act 1991
- Protection of Badgers Act 1992
- Conservation of Habitats and Species Regulations 2010 (and as amended)
- Environment Act 1995
- Countryside and Rights of Way Act 2000

To further illustrate the links between biodiversity and WFD, consider some of the European protected species which rely on a **high quality water environment** – otter, water vole, great crested newt and white clawed crayfish for example.



5.1.2 Policy

The National Planning Policy Framework (NPPF) gives guidance on integrating biodiversity and ecological considerations into the planning process. The consistent theme within the NPPF is of the importance of ecological networks which sits well alongside a catchment based approach to planning for the water environment.

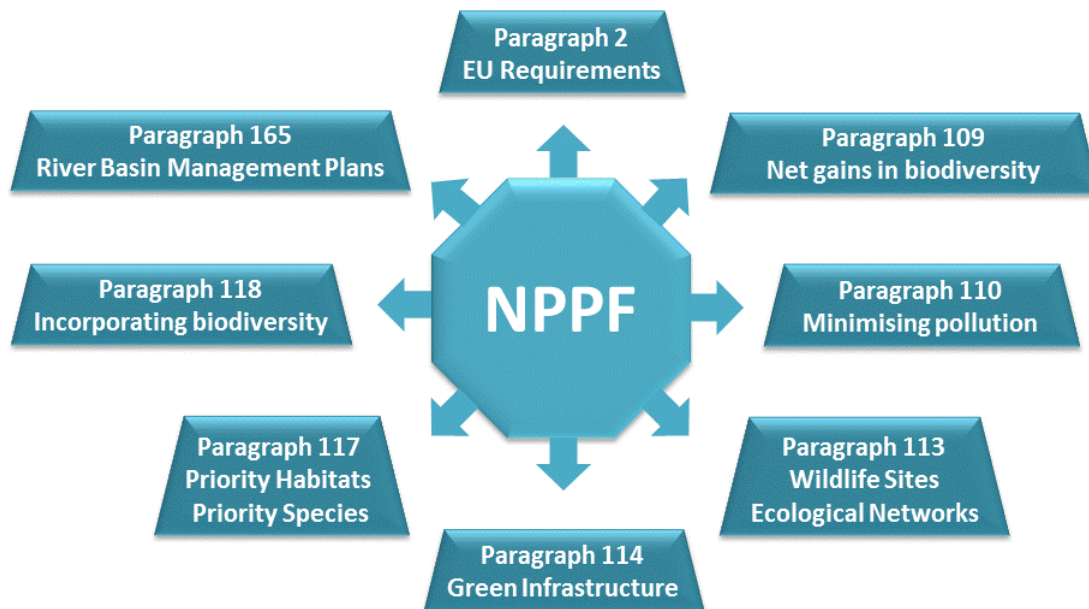

Figure 6: NPPF Paragraphs of direct relevance to WFD

How do these requirements fit into strategic planning and development management?

NPPF Paragraph	Strategic Planning	Development Management
<i>Paragraph 2</i> is clear that planning policies and decisions must reflect and, where appropriate, promote relevant EU obligations and statutory requirements.	✓ ✓	✓
<i>Paragraph 109</i> details how the planning system should contribute to enhancing the natural environment through minimising impacts on biodiversity and indeed providing net gains in biodiversity where possible. It also talks about establishing coherent ecological networks and protecting landscapes as well as preventing new development from contributing to water pollution .	✓ ✓	✓ ✓
Minimising pollution and other adverse environmental effects is also covered in <i>Paragraph 110</i> in reference to development plans.	✓ ✓	✓
<i>Paragraph 113</i> calls for criteria based policies against which proposals for any development on or affecting protected wildlife sites or landscape areas will be judged and again highlights the importance of wider ecological networks .	✓ ✓	✓
In referring to Local Plans , <i>Paragraph 114</i> talks about planning positively for the creation, protection, enhancement and management of networks of biodiversity and green infrastructure .	✓ ✓	✓
<i>Paragraph 117</i> gives guidance as to how planning policies should also promote preservation, restoration and re-creation of priority habitats and ecological networks as well as protection and recovery of priority species .	✓ ✓	✓
Where the primary objective of a proposal is to conserve or enhance biodiversity , <i>Paragraph 118</i> states that these should be permitted, with opportunity to incorporate biodiversity in and around developments also encouraged. However, it is clear that where adverse and unmitigable biodiversity impacts are identified, then permission should be refused.	✓	✓ ✓
River Basin Management Plans are listed in <i>Paragraph 165</i> as part of the evidence base which should be taken into account when developing planning policies and making planning decisions.	✓ ✓	✓

The full text of the NPPF can be found here:

<https://www.gov.uk/government/publications/national-planning-policy-framework--2>

5.1.3 What if WFD requirements are not met?

Article 4(7) of the WFD sets the criteria that must be applied when determining development applications. If a proposal is likely to lead to deterioration in the overall status of a waterbody, or prevent future attainment of good status, it must meet the following tests:

- Has all practicable mitigation been included?
- Are there reasons of overriding public interest?
- Do the benefits to human health, safety or sustainable development outweigh benefits to environment and society?
- Are better environmental options not technically feasible or cost proportionate?

These tests can be addressed through a WFD Assessment (see Section 5.3.3 for more information)

If WFD requirements are not met, then the EU can fine member states – The Localism Act 2011 (Part 2, s48) gives the power to require public authorities to make payments in respect of an EU financial sanction. In practice, it is likely that the Environment Agency would work with a local authority to resolve the situation and avoid penalty payments.

5.2 How Might Development Impact on the Water Environment?

Development can affect wetland habitats in a number of ways, for example through direct loss, increased detrimental edge effects, fragmentation, or indirect impacts such as changes in hydrology and diffuse and point-source pollution. It may be relatively straightforward to identify the potential for impact on waterbodies in close proximity to a development. However, where there are no apparent waterbodies nearby, consideration should still be given to WFD objectives given that all water eventually makes its way into the river system. For example, whilst an assessment of a proposal may consider protected areas, such as SSSIs, within 5km, it may actually be necessary to increase this distance to cover the whole catchment. Many of these sites may be reliant on stable hydrogeological conditions and could be negatively impacted by changes some considerable distance away. In any event, ***making improvements to water quality at source should be achievable regardless of the location of the development.***

5.2.1 Causes of poor water body status

Pressures on our water environment responsible for downgrading water bodies to less than 'good' status include:

- **Point source pollution**, such as effluent discharging from industrial sites, wastewater treatment plants or mines, and combined sewer overflows.
- **Diffuse source pollution**, which arises from many different sources rather than an obvious discharge point. Causes include run-off from impermeable urban surfaces which can carry a mix of pollutants; pollutants such as paints, oils and chemicals entering surface water drains; drainage 'misconnections'; general neglect and littering of water courses; water and pollution from agriculture in rural areas.
- Physical man-made **modifications** to watercourses such as straightening, impounding structures and culverts which can degrade habitat.
- **Low flows** in water bodies affected by drought or over abstraction.

- **Habitat degradation**, including man-made impacts and the effect of invasive non-native species, such as Himalayan Balsam and Japanese Knotweed, which crowd out native species.

Source: Local Authority Services and the Water Environment Executive Summary (Environment Agency, 2012)

How else might development have a negative impact on WFD objectives?

- × Increases in pollution to water courses through new/changed sources of discharges, such as industrial premises, houses and car parks.
- × Changes in volume or pattern of surface or groundwater flows that leads to disruption of natural habitats, such as through abstraction, mineral site dewatering and interception of surface flows.
- × Loss of natural features in water bodies, such as through channelisation, culverting, formalisation of river banks (rip-rap, creation of steps, moorings, jetties etc.)
- × Developments near watercourses that would lead to loss or degradation of habitats used by riparian species, such as loss of undisturbed habitat, or areas for feeding and breeding
- × Developments near watercourses that would lead to increased mortality of riparian species, such as new roads that could impact otters, or commercial crayfish farming that can affect white-clawed crayfish.
- × New uses that require abstraction, such as new industrial development.
- × Housing in inappropriate locations which can lead to increased littering along water courses, disturbance to species, polluted run-off, increased need for sewage treatment works and increased need for potable water supplies.
- × Increased impacts on waterbodies through new types of agricultural development, such as intensive indoor livestock units.
- × Even small developments near to watercourses can lead to problems of essential access for the EA and IDBs.

5.2.2 Improvements to the water environment which can contribute to positive WFD outcomes

Developments can also improve the water environment, for example through urban regeneration or conservation-led initiatives. This can be achieved in many different ways, for example including sustainable drainage solutions, making modifications to water courses to restore 'natural' rivers, buffering potentially harmful activities or overcoming barriers to fish movement. Figure 7 below illustrates just a few of the potential positive and negative effects of development on the water environment.

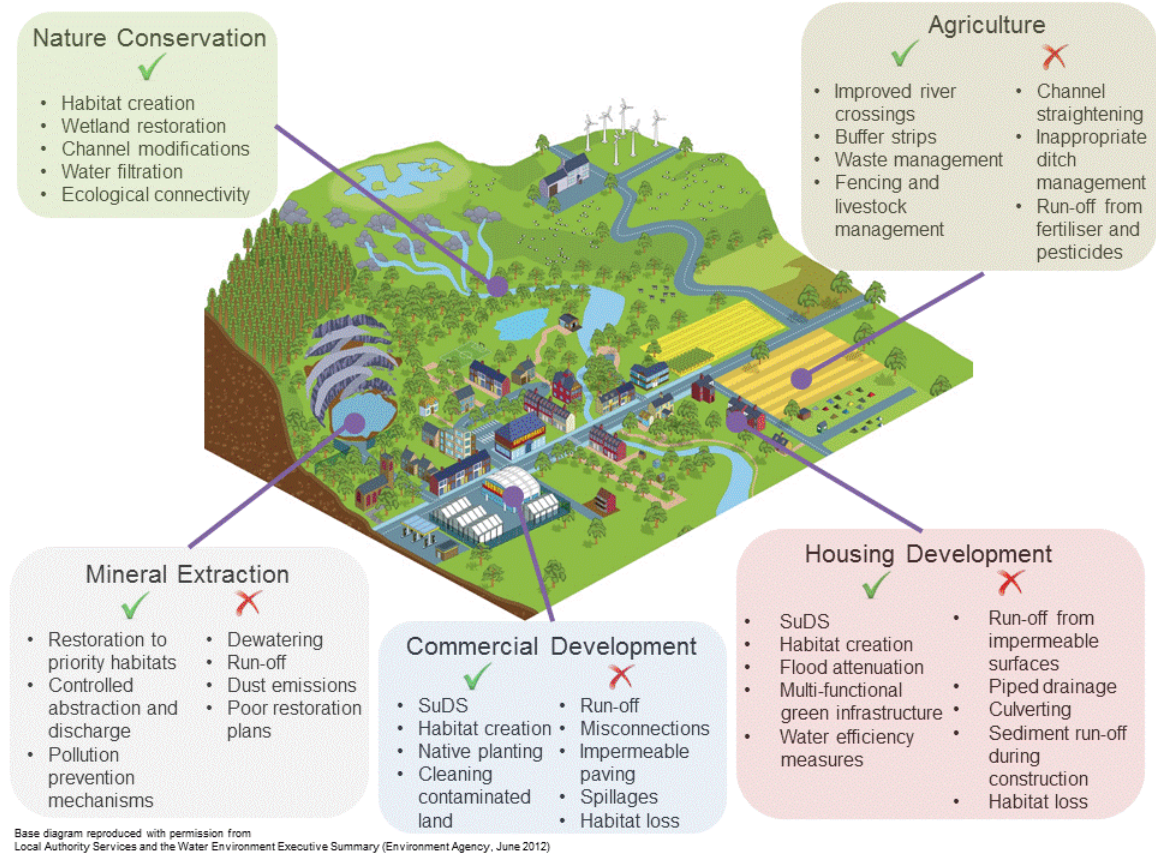

Figure 7: Some of the effects of development on the water environment

5.3 Measuring Water Quality Under the WFD

5.3.1 Overall Water Body Status

Under the WFD, the overall status of a water body is assessed through five key measures which reflect potential direct and indirect impacts.

- **Biological quality** - this is a measure of the biodiversity of the waterbody and the WFD assessment encompasses the assemblages of fish, invertebrates and aquatic flora. The WFD aims to conserve and enhance this diversity.
- **Hydromorphological structure** – this includes the river bank and bed structure and continuity of the watercourse, which can affect biodiversity in many different ways, e.g. whether there are suitable in-channel structures to enable fish to spawn, or for diverse marginal plants to grow. The WFD aims to restore hydromorphology to a more natural state where possible.
- **Specific pollutants** – these include metals and their compounds as well as organic compounds and can be introduced into the water course through a variety of mechanisms. All of these pollutants will have a detrimental effect of flora and fauna and the WFD seeks to eliminate such harmful inputs.

- **Physico-chemical quality** – the levels of dissolved oxygen, temperature, and the amount of nutrients (i.e. phosphates) all affect how successfully plants and animals can feed and breed and how they compete between species, e.g. if dissolved oxygen levels are too low, some species of fish will not be able to breed successfully. The WFD aims to bring all these factors to the optimum levels for the protection and conservation of riverine flora and fauna.
- **Chemical quality** – this is assessed as pass or fail and includes priority substances such as mercury and benzene. WFD aims to reduce and eliminate substances which present a significant risk to the water environment,

Early consideration of the water environment can enable these WFD aims and outcomes to be secured through the planning process, both in plans and policies and also via development control. Some of the specific areas which may be highlighted at a pre-application stage may include:

- Wastewater discharge and infrastructure
- Flood risk management
- Diffuse pollution
- Contamination, restoration and abstraction in minerals and waste planning
- Water resources
- Regeneration
- Loss of habitats
- Impacts on biodiversity

5.3.2 Consulting the experts for detailed assessment

The information needed to assess the potential impact of development on the water environment is often spread across a range of documents. Where an Environmental Impact Assessment (EIA) is carried out, the impacts will be collated and summarised to enable consideration of the whole development, although they will still be found across a number of different chapters within the Environmental Statement. For non EIA developments, it may still be necessary to request detailed assessments for specific areas such as ecology, flood risk and drainage. The recommendations given within these reports should be integrated into the overall design of the development at an early stage – they provide the evidence base and should lead the detailed design for the water environment.

5.3.3 WFD Assessment

Carrying out a WFD assessment (WFDa) enables consideration of the potential impact of the proposal on the water environment. The process is similar to that undertaken through EIA, however can be tailored specifically to identify solutions which will ensure no deterioration in WFD status as well as highlighting opportunities for ecological improvements and contributions to delivery of the RBMP.

A screening and scoping stage can be undertaken to identify affected waterbodies and to consider the potential links between hydromorphology and ecology. The impact assessment stage should co-ordinate expert opinion, taking into consideration sensitivity of the environment, likely direct and indirect impacts, the magnitude and direction of impact, cumulative impacts and timing. The overall aim is to decide whether deterioration is likely to occur, or if WFD objectives could fail to be met.

Following the assessment stage, the WFDa should contain either

- a) a statement of WFD compliance, or
- b) an explanation of how the scheme will meet the Article 4.7 tests

An eight-step approach to WFDa has been suggested by the Environment Agency to ensure that each of these stages is considered:

Eight-Step Approach to WFDa

- 1. Collect up to date waterbody baseline data*
- 2. Collect proposed scheme baseline data*
- 3. Preliminary assessment*
- 4. Design and options appraisal*
- 5. Detailed impact assessment*
- 6. Apply Article 4.7 tests*
- 7. Reporting*
- 8. Follow-up post-project appraisal work*

Adding WFDa to validation checklists is an easy way to ensure that consideration of the need for an assessment of potential impact on the water environment is included at an early stage of the planning process. An example checklist is included at Appendix B.

5.4 How Planners Can Contribute to WFD Targets

5.4.1 How can planners contribute to WFD targets in relation to the five key WFD measures?

When assessing any development proposal, planners should consider the following questions:

Biological quality

Are there improvements which could be made to benefit aquatic flora and fauna? For example, is there an opportunity for habitat creation or enhancement? What about protection of existing biodiversity – have appropriate surveys and impact assessments been carried out?

- ✓ Include landscaping with native, locally appropriate species
- ✓ Encourage use of reedbeds to improve water quality
- ✓ Create buffer zones to protect habitat areas
- ✓ Require green infrastructure connections

Hydromorphology

Can channel improvements be made, for example to revert to a more natural structure? Is it feasible to reduce culverting, make changes to flow rates or find better flood storage options?

- ✓ Reduce physical modifications
- ✓ Create more natural drainage
- ✓ Incorporate permeable areas
- ✓ Introduce water efficiency measures e.g. greywater systems



Specific pollutants, Physico-chemical quality and Chemical quality

How can the development reduce harmful inputs of sediments, chemicals and other compounds? Can solutions be found to reduce or eliminate inputs from farming, industry, residential and/or commercial operations?

- ✓ Use SuDs to reduce run off volumes and improve quality
- ✓ Request a drainage plan from applicant
- ✓ Require remediation of contaminated land



5.4.2 How can planning policies contribute to WFD objectives?

Local planning policies which can contribute to WFD objectives include those which:

- ✓ Require that development proposals do not lead to deterioration of WFD water body status, and which help to conserve and enhance watercourses and riverside habitats;
- ✓ Encourage development proposals to improve the water environment, e.g. restoring natural watercourses through the removal of culverts and hard engineered structures, physical improvements to riverbanks and habitats, development of green infrastructure, overcoming barriers to fish movement, urban regeneration or conservation projects, especially in relation to water bodies rated as having poor ecological status;
- ✓ Protect sensitive locations, for example wetland habitat and local abstraction points that may be protected areas in the RBMP;
- ✓ Require upgrades to local water infrastructure (water supply, wastewater sewerage and treatment, flood risk management, sustainable drainage and green infrastructure), for example, for strategic development sites in site specific/site allocation policies and Infrastructure Delivery Plans;
- ✓ Require planning applications that result in wastewater or surface water to be drained to be accompanied by a water management statement which identifies water cycle issues relevant to the development proposal and the means of addressing these;
- ✓ Require developments which adjoin a watercourse to be set back to enable access and enhancement of bankside habitats;
- ✓ Require efficient use of water in new buildings and refurbishments, and if justified by local evidence, higher levels of water efficiency beyond those set out in Building Regulations Part G;
- ✓ Encourage the incorporation of sustainable drainage systems into new developments and retrofit of SuDS to reduce the risks of flooding and enhance water quality and ecology;
- ✓ Require the use of environmental assessments for any proposed schemes where the local evidence shows that development might have significant impacts on water bodies.

Source: Advice Note on the Water Framework Directive for Local Authorities across the Midlands (Environment Agency, 2012)

5.4.3 Case studies

Appendix A provides a number of brief case studies illustrating how the planning system can contribute to WFD targets through measures such as water course improvements and sustainable drainage solutions. The studies also highlight where there may have been the opportunity to secure better outcomes.

Many developments can contribute to positive WFD outcomes through use of sustainable drainage solutions. For more information on delivering SuDS, numerous further case studies and other resources, see the Susdrain website:

<http://www.susdrain.org/>

5.4.4 Lessons learned

Lessons can be learned from examination of these case studies, summarised in Figure 8 below. Considering WFD at an early stage and throughout the process is key to ensuring that projects are compliant. However, for this to happen it may be necessary to first educate and raise awareness of WFD requirements and objectives. Ultimately, project design options are likely to be site-specific and driven through expert consultation. Taking a strategic approach to delivering WFD objectives could lead to large-scale, high level schemes across whole catchments.



Figure 8: Key lessons which can be learned from consideration of case studies

6.0 Guidance for Highways Departments

County or Unitary Councils have the statutory responsibility for the non-trunk road network within their area whilst major trunk roads come under the remit of the Highways Agency. District Councils are usually responsible for street cleaning and may work in partnership with the County Council on other aspects of highway management. Local Authority highway departments cover all aspects of highways including planning, design, drainage, maintenance, resurfacing, repair, gritting, managing street works and road signs.

As roads can be a major source of direct and diffuse pollution, the Local Authority has a key role to play in managing and controlling the volume and quality of highways run-off. Unless properly managed, runoff water from highways can carry a variety of polluting substances into the watercourse and contribute significantly to local flood risk, poor water quality and ultimately failure to achieve WFD targets.

6.1 Examples of good practice in local authority highways functions to protect the water environment and provide WFD benefits

The following sections give some suggestions for areas which should be considered when assessing potential WFD-related impacts of a proposal.

6.1.1 Assessment of pollution and flood risk from new and existing road networks

When planning the year's highway work program, it is good to work through some checklists and best practice advice. This is of particular importance as more groups are looking to improve water quality - highways play an important role in the pathway of water from source to outfall. Below are some of the ways to reduce highways impacts.

- Use of environmental assessment tools (incorporating consideration of the water environment) for ensuring that new road projects minimise water pollution and flood risk.
- Where a potential pollution or flood risk is identified as part of an environmental impact assessment, decisions and drainage design should be used to mitigate these risks.
- Work with the Environment Agency in identifying water pollution and flood risk potential from existing road networks, identifying any high risk areas.
- Work with the Environment Agency in identifying permitting requirements for discharges from highways into watercourses.
- Developing a programme of works to install treatment or containment measures at existing highways drainage outfall sites that have been identified as posing a potential pollution risk.

6.1.2 Road design

Design of road drainage for new roads should include appropriate SuDS to channel and attenuate excess water from roads to prevent flooding and improve water quality. Additionally, designs should seek to incorporate engineered solutions using infiltration, storage and attenuation, flow control and water treatment.

Potential techniques include the use of:

- porous surfaces, such as porous asphalt and block paving;
- kerbs and gullies, incorporating gully pots, sediment traps, silt traps and oil separators;
- swales – shallow vegetated channels designed to convey road runoff and treat pollutants;
- roadside filter drains, sand filters, infiltration trenches and vegetated filter strips alongside roads;
- engineered stormwater filtration and treatment systems;
- bioretention – shallow landscaped depressed areas that are under drained and rely on enhanced vegetation and filtration to reduce runoff volumes and remove pollutants;
- storage and overland flow – using ponds, wetlands, basins, balancing ponds, soakaways and detention/infiltration basins;
- creation of wetlands, woodland strips to slow down the pathways.

For detailed guidance on maximising the potential of SuDS for people and wildlife, see the following document: [Sustainable Drainage Systems \(WWT, 2013\)](#)

6.1.3 Other considerations

Where roads are constructed through brownfield contaminated sites, measures will be required and SuDS schemes will need to be designed carefully to prevent pollutants seeping out of contaminated soils into surface or groundwater.

Retrofitting of SuDS into an existing road scheme may be a possible option; for example, during road reconstruction and resurfacing work, new development or residential expansion. SuDS techniques which can be suitable for retrofit include: installation of sediment traps, silt traps and oil separators, roadside filter strips, basins, ponds, filter drains, swales and porous road and pavement surfaces.

6.2 The benefits of SuDS

There is a growing acceptance that we need a more sustainable approach to managing surface water. SuDS mimic natural drainage processes to reduce the effect on the quality and quantity of runoff from developments and provide amenity and biodiversity benefits. When specifying SuDS, early consideration of the potential multiple benefits and opportunities will help deliver the best results.

6.2.1 Flood risk management – reducing the risk of flooding from roads

During high rainfall events roads can act as pathways for water, speeding up the transport of water to rivers that maybe close to flooding, or carrying water to properties. By having a good SuDS network alongside roads, these problems can be reduced.

- Water resources – where appropriate, SuDS can help to recharge groundwater supplies and capture rainwater that may be re-used
- Enabling new development – SuDS can help to free up capacity in already established drainage networks.

6.2.2 Water quality management

Diffuse pollution is a problem in most river catchments. Many roads, especially rural roads, show high levels of sediment following periods of rainfall, which is confirmed by turbidity measurements, or just seeing the rivers turning brown after rainfall.

This diffuse pollution on our roads can be littered with numerous contaminants (such as oil, sediments, fertilisers, pesticides, animal waste and litter) that can adversely affect the environment. Water quality improvements are often not well-managed by traditional piped drainage. Pollutants or contaminants can be washed into sewers and eventually watercourses in surface water runoff, making it difficult to comply with water quality legislation.

Some SuDS components provide quality improvements by reducing sediments from runoff either through settlement or biological breakdown of pollutants. It is important to carry out wet weather surveys to identify where substantial amounts of mobilized sediments occur on highways and to observe the pathway to the watercourse via the network of roadside ditches, gullies and subsurface conduits. This information can be helpful in addressing where to work with landowners to reduce sediment mobilization and where to incorporate SuDS if necessary.

Table 6.1 below lists different pollutants which can be found in road runoff and their impacts on freshwater ecosystems.

Table 6.1: The Constituents of highway runoff and a summary of their impacts on freshwater ecosystems

Component	Runoff Risk	Impact	Potential Consequences for river	Notes
Sediment	High	High	<p>Concretion - loss of aquatic habitat by blocking the voids in gravels depriving the substrate of oxygen to suffocate juvenile pearl mussels, the eggs of host salmonids and benthic invertebrates .</p> <p>Increase in turbidity reducing photosynthetic light</p> <p>Changes in pH</p> <p>Clog gills of fish, damage feeding and respiratory function invertebrates</p> <p>Damage mucus membranes of host salmonids increased mortality</p> <p>Vector of other pollutants</p> <p>Modified channel morphology and reduction in flow velocity encouraging further deposition</p>	
Nitrate Nitrogen	High	High	<p>Eutrophication - promotes excessive algal growth.</p> <p>Decomposition of algae raises biological oxygen demand (BOD) in the river to stress sensitive aquatic organisms.</p>	Highly soluble and readily lost from soils

Component	Runoff Risk	Impact	Potential Consequences for river	Notes
Phosphate	High	High	Eutrophication as Nitrate	Bioavailable in FYM and slurry
Ammonia	High	High	Gill and skin hyperplasia in host salmonids Highly toxic to host salmonids and other aquatic life Eutrophication when converted to nitrate	Multiple sources and pathways Poultry and cattle units
Pesticides	High	Lethal/ Sublethal	Invertebrates, crustaceans , molluscs at risk from insecticides and molluscicides Phytoplankton, macrophytes at risk from herbicides Top predators at risk due to bio-accumulation	
Organic Material	High	High	Biodegradation Raises BOD and deoxygenates water Increased eutrophication Organic sedimentation Elevated metals (zinc and copper) from pig and poultry waste Toxic to pollution sensitive invertebrates Low dissolved oxygen prevents passage of host salmonids and kills salmonid eggs Increase in turbidity reducing photosynthetic light	Propagated by spreading of cattle slurry, yard runoff and subsequent surface runoff
Veterinary Medicines & Endocrine Disrupting Chemicals	High	Sublethal	Avermectins toxic to aquatic organisms Worming agents toxic to invertebrates and molluscs	Propagated by spreading of cattle slurry, yard runoff and subsequent surface runoff
Road Salt	High	Unknown	Toxic to aquatic organisms Local salinization particularly of minor watercourses Increased mobilisation of heavy metals in soils Can contain impurities such as trace metal and cyanide Sediments Increased turbidity	Pre 1940s virtually no chloride in rural freshwater possible long-term implications
Hydrocarbon	High	Sub lethal	Un-burnt vehicle fuels, oils, asphalt sealant	
Heavy Metals	High	Sublethal	Trace elements can bio-accumulate in the environment - phosphate fertilisers can contain cadmium. Pig and poultry waste, copper and zinc. Road salt, cyanide	Roadside deposition from vehicles can be mobilised through vehicle overrun

6.3.3 Amenity and biodiversity benefits

SuDS components (like ponds and wetlands) can provide an array of amenity, recreational and biodiversity benefits. However, they will only fulfil their ecological potential if their design criteria consider ecology, flood risk and water quality management together.

SuDS provide opportunities to create visually attractive green (vegetated and landscaped) and blue (water) corridors in developments and along highways connecting people to water.



New access roads in developments and new highways should consider the biodiversity pathways that exist in the area and build on these with well-designed SuDS. Highways SuDS can also contribute to green and blue infrastructure for new developments – see further guidance at http://www.ceeweb.org/wp-content/uploads/2015/03/Training_Manual_v3-Copy.pdf

6.4 Highways SuDS Design

A suitable SuDS design should encompass a comprehensive management train and should mimic the behavior of a natural catchment. Drainage techniques can be used, in stages, to change the flow and quality characteristics of the runoff.

As illustrated in Figure 9 below, the management train starts with prevention for individual sites and progresses through local source controls to larger downstream sites and regional controls. Runoff need not pass through all the stages in the management train - it could flow straight to a site control. As a general principle, it is better to deal with runoff locally and return the water to the natural drainage system as near to the source as possible. There will be many partners in a local Catchment Partnership who will also be working to prevent run-off from land, so talk to the local Catchment Coordinator or Catchment Host (see Section 4.5) who can put you in contact with other partner organisations. Only if the water cannot be managed on site, due to it requiring additional treatment before disposal or the volume of runoff generated being greater than the capacity of the natural drainage system at that point, should it be conveyed elsewhere. Dealing with the water locally not only reduces the volume that has to be managed at any one point, but also reduces the need for conveying the water off the site. Early consideration for the use of SuDS should be undertaken to ensure effective site selection and design.

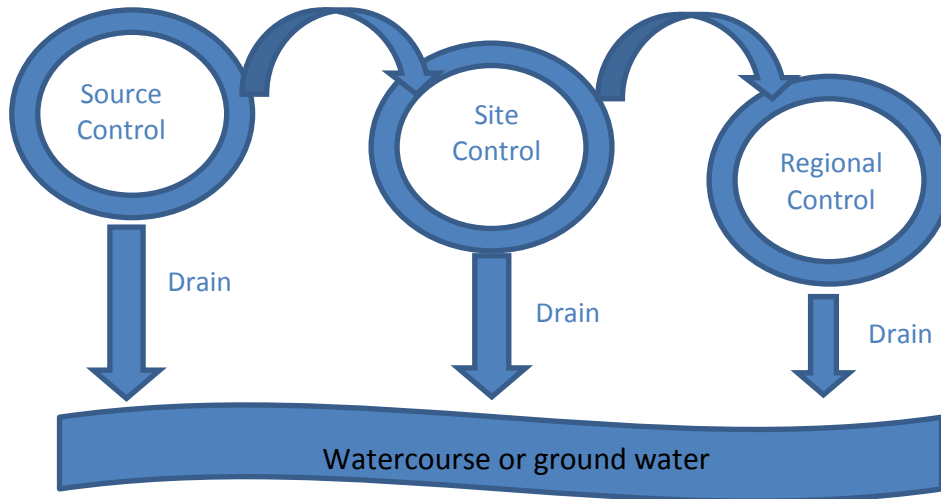

Figure 9: Treatment stages within the management train

6.5 Highways and street maintenance

It is important at each stage of highway maintenance that water quality is considered. Highways maintenance is important to ensure blockages are prevented and drainage systems perform effectively. However, some maintenance could increase runoff and diffuse pollution if only highway flooding is considered in isolation.

It is key to monitor where cleaning of gully pots and silt traps are required more frequently, so these can be undertaken after heavy rain events and to work with partners in the Catchment Partnerships and look for local solutions. There may be a local Land Advisor working with farmers to reduce run-off and the Highways department can link up with local organisations to reduce silt getting onto the road and blocking the gullies.

Working with local Land Advisors can help to identify where grips could be cut into the road verges and potentially into neighbouring fields to reduce water on the highway. Badly planned grips, however, can exacerbate run-off from farm fields into a watercourse.

Management of winter salt and gritting operations needs to be considered to minimise polluting runoff and impacts on the water environment. This is in addition to management of pesticide and herbicide use alongside roads to avoid impacts on water quality and water body ecology, including training of spray operators.

6.6 Rural Roads – case study

In many parts of the UK rural runoff is a contributing factor to flooding. Approaches using land management practices to deliver flood risk management are supported by Making Space for Water, the Water Framework Directive, Future Water and The Pitt Review. There is strong evidence that small scale catchment management approaches deliver flood risk management benefit.

To begin to address this issue in the southwest of the UK, as detailed in Dorset's Local Flood Risk Management Strategy, Dorset County Council plans to "Work with Natural England and the Environment Agency to engage with landowners to advice and encourage catchment sensitise farming methods to reduce runoff". Additionally, working partnerships may also be established with Wessex Water and Farming & Wildlife Advisory Group South West (FWAGSW).

Three pilot schemes were selected in a Flood and Water Framework Directive (WFD) meeting that included representatives from Dorset County Council, The Environment Agency, Natural England, Wessex Water, Farming & Wildlife Advisory Group, Dorset Area of Outstanding Natural Beauty and Dorset Wildlife Trust.

In these pilot schemes the main objective is to implement land use changes that help reduce the risk of surface water flooding.

Additional objectives are:

- Develop the processes for Dorset County Council to work with partners across Dorset on further rural runoff issues
- Look into future partnership funding options to address rural runoff
- Achieve multiple benefits for water quality, ecosystem functionality and biodiversity
- Explore opportunities to create guidance that can be shared

Land Advisors from FWAGSW will be alerted to dirty roads and will visit the landowner and help them to understand the problem and look for solutions. If there is a repeat problem on the road coming from the farm, further action will be taken. Also Land Advisers will be working with land managers to reduce run-off onto roads and in address problems at source so highway drains cannot be blocked and this should reduce problems and costs.

6.7 Accidental spillages and incident response

Unfortunately accidents do happen and often spills from vehicles, machinery, fire etc. can and does happen. Therefore it is important that there is a plan in place and local highway staff know what to do to minimize pollution. Two important factors in ensuring a rapid and appropriate response to incidents are:

- Close working by local authorities with partners such as the Environment Agency and fire and rescue service to control pollution risk from accidental spillages of fuels, chemicals or other polluting materials on highways or incidents.
- Staff trained in the use of spill containment kits, on highways and highways depots. Storage of materials at local authority highways depots to avoid pollutants entering surface water drains.



7.0 Guidance for Greenspace Departments

Green infrastructure (GI) is a concept concerning the consideration of the natural environment in decisions about land use planning. It includes parks, open spaces, playing fields, woodlands, wetlands, grasslands, cemeteries, rivers and canals, allotments and private gardens.

In addition, it includes 'blue space', such as water bodies, rivers, streams, floodplains and sustainable drainage systems. It also covers aspects of environmental management, such as flood management, better air and water quality, and the provision of shade and shelter in and around towns and cities.

Although the scale and range of Local Authority greenspace and countryside services differs widely across the country, these services can make a valuable contribution to a wide range of WFD objectives from the management of sites and green spaces to work on Rights of Way, road verges and community engagement and flood management.

In urban areas - towns and cities, rivers have huge potential to provide a place for people to connect with nature. River restoration can transform uninteresting concrete channels into havens for people and wildlife and help sort out water quality. For more information on developing urban blue corridors, see: [Developing Urban Blue Corridors – Scoping Study](#)

7.1 Green infrastructure networks can be used to reduce surface water run-off, store flood water and improve water quality

Many GI sites have a watercourse associated with them, either surface water which has been culverted or surface water drains. When looking at developing, creating and/or restoring green infrastructure there should be a presumption in favour of open water courses through channel restoration and de-culverting, so a more natural and slower response to heavy rainfall can be achieved. Conserving river corridors can help to absorb fluctuating water volumes as well as increasing their aesthetic quality, biodiversity and public enjoyment.

Research by the University of Manchester has shown that:

- increasing the green space cover in urban areas by 10 per cent reduces surface run-off by almost 5 per cent
- increasing tree cover in urban areas by 10 per cent reduces surface water run-off by almost 6 per cent
- adding green roofs to all the buildings in town centres can reduce surface water run-off by almost 20 per cent

Source:

<http://webarchive.nationalarchives.gov.uk/20110118095356/http://www.cabe.org.uk/sustainable-places/advice/green-infrastructure-and-flood-risk>

7.2 Planning green and blue Infrastructure

Various studies have highlighted the value of green space including a wide range of benefits relating to health, biodiversity, quality of life and the economy. Increasing green space also has a significant effect on reducing run-off by absorbing more water. One study showed a 5% reduction in run-off from a 1% increase in green space in a residential area.

Land uses across regions and cities should be planned to maximise the potential beneficial impacts on catchment management and run-off. Using landscape character assessment to assess the suitability of land uses can be helpful in achieving this. Factors such as land cover, habitat, soil type, topography and groundwater will combine to influence such character-based decisions.

7.2.1 Regional or catchment scale

The regional scale is the starting point for environmental assessment and landscape character work and is therefore an appropriate scale for thinking jointly about green and blue infrastructure, or water management. This joint approach should be advocated and investigated as part of strategic environmental assessments and the regional and smaller scales.

7.2.2 Town or city scale

At the city scale, some cities have found immense value in producing green and blue grid strategies that encompass both green infrastructure and water management objectives. By establishing a clear strategy for water management and identifying its functions (existing and potential) in accordance with the principles of water sensitive urban design these documents can steered planned developments towards more sustainable solutions. As a rule, open space planning should integrate multi-functional use of public open space with flood water attenuation in green space, parks and sports facilities. This includes protecting wetlands as natural sites for surface water management and treatment and incorporating wetland creation in planning processes.

7.2.3 Site scale

At a site scale, public green spaces should be designed to incorporate a balance of hard and soft landscape elements to meet surface water challenges. Both planting and surfacing should minimise surface water run-off in addition to meeting other design requirements, i.e. the use of native species in planting to benefit wildlife and increase biodiversity. Opportunities to maximise permeable paving, retrofit and maintain existing catch basins have a part to play in hard landscaping. Ensuring creative design of new and refurbished water features such as lakes, ponds and wetlands network can add distinctive character to a site and increase its value for people and wildlife.

7.3 Multifunctional value of green space

Sequential flood risk assessments should be undertaken in conjunction with open space strategies so that there is full consideration of the multi-functional value of green space, wetland networks and river corridors rather than isolated consideration of buildings in relation to flood risk.

Some types of development and green infrastructure are more 'water compatible' – and therefore suitable to be located in the floodplain. These include amenity open space, nature conservation and biodiversity, outdoor sports and recreation and essential facilities such as changing rooms, flood control infrastructure, water transmission infrastructure and pumping stations and sewage transmission infrastructure and pumping stations.

Contact your local catchment partnership and /or your local wildlife NGOs early in the planning of GI as they will be aware of local biodiversity issues and how incorporating certain features or species in the design can solve issues early and create benefits.

7.4 Managing green spaces

When managing green spaces, it is important to consider the wider site in addition to any waterbody which is present. This section gives some guidance on areas to focus on which can provide WFD benefits, illustrated in Figure 10.

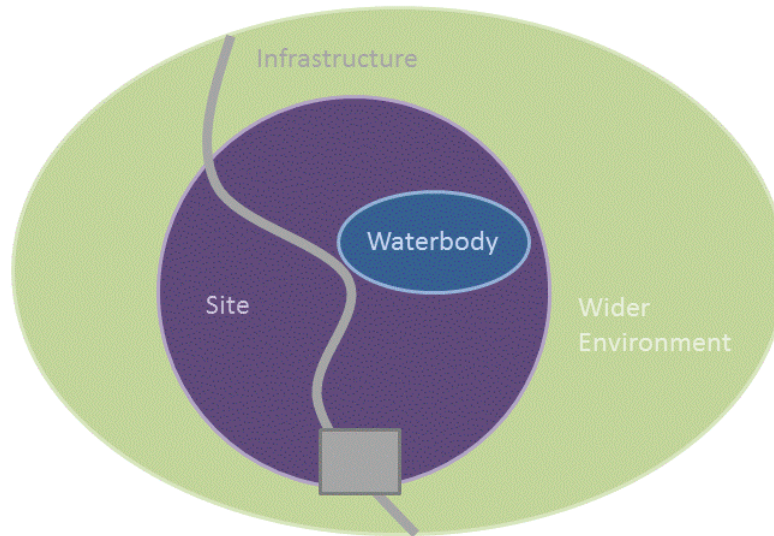

Figure 10: Greenspace management areas

7.4.1 Managing the waterbody

- Managing water bodies within green spaces and sites to conserve and enhance biodiversity including fish, invertebrates and flora. Developing opportunities to manage or influence the management of water bodies on adjacent or linked sites.
- Designing and maintaining drainage schemes on Local Authority sites and land to provide valuable flood management, water quality, ecological and amenity benefits. Where possible, managing upstream sites and countryside projects to capture agricultural run-off and reduce levels of phosphates, nitrates and other pollutants, for example, through wet woodland and reedbed creation.

7.4.2 Managing the management of the site

- Careful management of grass cutting regimes on sites, playing fields and road verges. Where possible reducing the frequency of mowing to reduce rates of surface water run-off and related risks of sediment loading and pollution. Longer grass areas have a greater capacity for water retention and infiltration, and buffer zones alongside water courses also help to filter out potential pollutants and provide bankside habitat benefits.

- Planting and managing trees in appropriate areas which can dramatically increase rain infiltration rates into the ground, decrease wind speeds, enhance biodiversity, improve air quality and provide shade
- Managing invasive non-native species including Himalayan Balsam, Japanese Knotweed, Floating Pennywort and Giant Hogweed. These can have significant impacts on watercourse ecology by suppressing the growth of native flora, damaging wildlife habitats, impeding water flow and increasing flood risk. Control efforts help reduce the spread of invasive non-native species and are especially successful when delivered through a catchment based approach.
- Correct use of any pesticides and herbicides through appropriate training of spray operators and adoption of good practice such as in the Amenity Forums briefing note on '*Pesticides and water protection for sprayer operators*' (see the Amenity Forum website at <http://www.amenityforum.co.uk/index.html>).

7.4.3 Managing the infrastructure

- Managing any buildings on site to minimise pollution and other detrimental effects. Ensuring environmentally sustainable features are introduced wherever possible, these might include: rainwater harvesting, woodfuel heating system and waste management schemes. Implementing water efficiency measures on site and encouraging water efficiency practices amongst site users and local residents
- Using on-site information and interpretation to raise public awareness and understanding of the freshwater environment and water management issues
- Improving surfacing and drainage within the RoW network to minimise agricultural run-off, pollution and sediment loading. Ensuring any structures or ground works relating to Rights of Way and other countryside management work don't have a detrimental effect on rivers and the continuity of the watercourse. Where feasible, developing opportunities to improve the structure of the watercourse through management work and restore rivers to a more natural state
- Linking with local communities to raise awareness and engage the public in the delivery of WFD objectives. Supporting community-led initiatives, including access projects, habitat improvements, litter clean ups, recreation and education activities. Developing local volunteer resources, often working in partnership with other organisations

7.4.4 Wider working

- Working with farmers and rural businesses to promote awareness of reduce the risk of water pollution and encouraging more effective water management.
- Working with a wide range of partners in the public and voluntary sectors to help integrate environment issues into their work and raise awareness of the value of good quality water.
- Ensuring that water environment issues are integrated into Local Authority services delivered by third parties, such as management of biodiversity, green space delivered by voluntary and private sector contractors and local communities
- Influencing the wider local government organisation to ensure that WFD issues are being integrated into the work of the authority across all departments. Encouraging good practice at a political and senior management level, and building good working relationships with external partners.

8.0 Working in Partnership

There are many organisations involved in delivering WFD targets who can be contacted for information and advice:

Environment Agency

<https://www.gov.uk/government/organisations/environment-agency>

DEFRA

<https://www.gov.uk/government/organisations/department-for-environment-food-rural-affairs>

Internal Drainage Boards

<http://www.ada.org.uk/idbs.html>

Local Catchment Partnerships

<http://www.catchmentbasedapproach.org/>

Local Lead Flood Authorities

http://www.local.gov.uk/local-flood-risk-management-/journal_content/56/10180/3572186/ARTICLE#lead%20local

Non-Governmental Bodies

i.e. The Wildlife Trusts <http://www.wildlifetrusts.org/>

Water companies

i.e. Severn Trent Water <http://www.stwater.co.uk/>

9.0 Useful Links

9.1 Rivers and Catchments

River Basin Districts

<https://consult.environment-agency.gov.uk/portal/ho/wfd/water/choices?pointId=2416646>

Link to a map of River Basin Districts in England and Wales

River Basin Management Plans

<https://www.gov.uk/government/collections/river-basin-management-plans>

More information on RBMPs which set out measures to improve water in rivers, lakes, estuaries, coasts and in groundwater.

Catchment Based Approach: Improving the quality of our water environment. (DEFRA, 2013)

<https://www.gov.uk/government/publications/catchment-based-approach-improving-the-quality-of-our-water-environment>

Document providing general information on the Catchment Based Approach to water management, including objectives and key ways of working

Catchment Change Management Hub

<http://ccmhub.net/the-catchment-approach/what-is-catchment-management/>

Website giving further information on catchment management, including tools, resources and case studies.

CaBA Website

<http://www.catchmentbasedapproach.org/>

Information hub for Catchment Partnerships

9.2 Legislation and Policy

Conservation of Habitats and Species Regulations 2010

<http://www.legislation.gov.uk/ukxi/2010/490/contents/made>

Convention on Biological Diversity 1992

<http://www.cbd.int/convention/>

Council Directive on the Conservation of Natural Habitats and of Wild Fauna and Flora 1992

http://ec.europa.eu/environment/nature/legislation/habitatsdirective/index_en.htm

Council Directive of the Conservation of Wild Birds 1979

http://ec.europa.eu/environment/nature/legislation/birdsdirective/index_en.htm

Countryside and Rights of Way Act 2000

<http://www.legislation.gov.uk/ukpga/2000/37/contents>

Environment Act 1995

<http://www.legislation.gov.uk/ukpga/1995/25/contents>

Environmental Protection Act 1990

<http://www.legislation.gov.uk/ukpga/1990/43/contents>

Land Drainage Act 1991

<http://www.legislation.gov.uk/ukpga/1991/59/contents>

National Planning Policy Framework (NPPF)

<https://www.gov.uk/government/publications/national-planning-policy-framework--2>

Protection of Badgers Act 1992

<http://www.legislation.gov.uk/ukpga/1992/51/contents>

Water Environment (Water Framework Directive) (England and Wales) Regulations 2003

<http://www.legislation.gov.uk/uksi/2003/3242/contents/made>

Water Framework Directive

<http://eur-lex.europa.eu/legal-content/EN/TXT/HTML/?uri=CELEX:32000L0060&from=EN>

Wildlife and Countryside Act 1981 (as amended)

<http://www.legislation.gov.uk/ukpga/1981/69>

9.3 Sustainable Drainage

Susdrain Case Studies

<http://www.susdrain.org/>

Water sensitive urban design in the UK

<http://www.ciria.org/documents/wsudreport/index.html#/20/>

Water sensitive urban design is the process of integrating water cycle management with the built environment through planning and urban design. This document considers how a water sensitive house, block of flats, neighbourhood, commercial area, development and city might look.

Biodiversity and Urban Design: An Architect's Guide

http://www.nottinghamshirewildlife.org/images/uploads/Architects_Guide_reduced_filesize.pdf

Design guidance for development

Green Infrastructure

http://www.ceeweb.org/wp-content/uploads/2015/03/Training_Manual_v3-Copy.pdf

Manual for practitioners to help raise awareness about green infrastructure.

Sustainable drainage systems: Maximising the potential for people and wildlife

https://www.wwt.org.uk/blog/wp-content/uploads/2013/01/SuDS_report_final_tcm9-338064.pdf

The guidance manual – *Sustainable drainage systems: maximising the potential for wildlife and people* – breaks down the steps to creating high value green spaces at low cost. These have the attractive potential to be liveable spaces that bring communities together and benefit wildlife, while making the landscape more resilient to climate change. It has been written specifically for local authorities, which are responsible for

authorising plans for sustainable drainage systems, landscape architects, developers, engineers and master planners

9.4 Planning and WFD

Advice Note on the Water Framework Directive for Local Authorities across the Midlands (Environment Agency, 2012)

<http://www.emcouncils.gov.uk/write/LA%20Services%20and%20the%20Water%20Environment%20Advice%20Note.pdf>

Advice Note providing information to local authorities on the important contribution they can make to local improvements in the water environment and to meeting the objectives of the Water Framework Directive.

Local Authority Services and the Water Environment Executive Summary (Environment Agency, 2012)

<http://www.emcouncils.gov.uk/write/LA%20Services%20and%20Water%20Environment%20Exec%20Summary.pdf>

Summary document with information on WFD and Local Authorities

Planning Advice for Integrated Water Management

<http://www.ciwem.org/policy-and-international/current-topics/water-management/planning-advice-for-integrated-water-management.aspx>

This Advice Note provides a one-stop-shop to de-mystify water management and demonstrate the benefits of building it into plans and planning decisions. It shows planners how to turn the challenges of managing water into opportunities, to provide the new homes and infrastructure that communities need at lower financial, environmental and social cost. Over 30 case studies of best practice, drawn from across the water sector, support the Advice Note by showing planners what is possible.

Building a Better Environment (Environment Agency, 2013)

https://www.gov.uk/government/uploads/system/uploads/attachment_data/file/289894/LT_2745_c8ed3d.pdf

This document gives an overview of the role of the EA, Forestry Commission and Natural England in the development process as well as initial advice on how to manage the environmental impact and opportunities of development. It also signposts to further information and provides links to the consents and permits which may be required.

9.5 River Restoration

Rivers by Design

<http://www.ecrr.org/Publications/tabid/2624/mod/11083/articleType/ArticleView/articleId/3468/Rivers-by-Design.aspx>

A step by step guide for planners, developers, architects and landscape architects on how to maximise the benefits of river restoration in development projects

Manual of River Restoration Techniques

http://www.therrc.co.uk/rrc_manual.php

Manual which aims to help river managers identify potential restoration techniques for use in river restoration and sustainable river management, including 64 case examples

European Centre for River Restoration (ECRR)

<http://www.restorerivers.eu/>

The ECRR is a European network based on a framework of national networks (national centres for river restoration) whose mission is to enhance and promote river restoration and sustainable river management throughout Europe, to disseminate information on river restoration experiences and approaches and to foster the establishment of national river restoration networks in as many European countries as possible. It shares the same goals of many river restoration national centres, but it acts at the international level, as a "network of networks". The website provides information on how and why to restore rivers, both in rural and urban locations.

European Centre for River Restoration (ECRR) Healthy Catchments

<http://www.restorerivers.eu/RiverRestoration/Floodriskmanagement/HealthyCatchments/managingforfloodriskWFD/tabid/3098/Default.aspx>

Information on river catchments, managing water for flood risk and the Water Framework Directive

Riverwiki

http://riverwiki.restorerivers.eu/wiki/index.php?title=Main_Page

Interactive case study database from around Europe

9.6 Highways

Design manual for roads and bridges

<http://www.standardsforhighways.co.uk/ha/standards/dmrb/vol4/section2.htm>

Section 2 of this manual looks at drainage options and design

The Pitt Review

http://webarchive.nationalarchives.gov.uk/20100807034701/http://archive.cabinetoffice.gov.uk/pittreview/thepittreview/final_report.html

Report produced following the 2007 floods

SuDS for Roads

<http://scots.sharepoint.apptix.net/roads/General%20Publications/SuDS%20for%20Roads/20100805%20SUDS%20for%20Roads%20-%20FINAL%20Version.pdf>

Guidance document with Scottish focus, but remains relevant to the rest of the UK

Appendix A

Case Studies

- ❖ Asda – Abbey Lane, Leicester
- ❖ Barkbythorpe, Leicester
- ❖ Grangewood Manor, Leicestershire
- ❖ Hucknall Town Centre Improvement Scheme, Nottingham
- ❖ Ring Road Major Improvement Scheme, Nottingham
- ❖ Durlston Centre Pond, Swanage
- ❖ River Piddle Trackways, Dorset

Case Study – Asda, Abbey Lane Leicester

As part of the planning permission attached to this 40,000 sqft supermarket with associated car park development, a sustainable drainage system was conditioned in order to meet both flood risk and water quality objectives. The site lies close to the River Soar and a sustainable solution was required to manage the quantity and quality of surface water run-off.

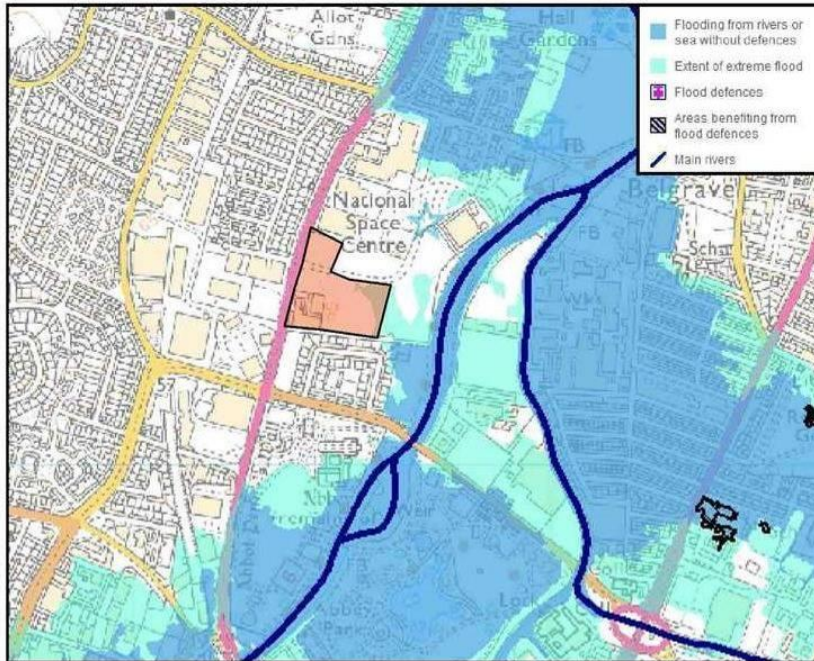

Figure 1 Flood map showing proximity of the site to the River Soar

Permeable paving was not considered an option due to issues with durability and pedestrian use, so two linear drainage solutions were installed to take surface water, with pollution-reducing filtration systems also in place. The final destination for the water is a vegetated swale which acts not only to store water and further reduce pollution, but is also a new wetland habitat with native species planted for biodiversity benefit

Further detail of the scheme is given in the YouTube clip here:

<https://www.youtube.com/watch?v=EE7IyIvG0Lg>

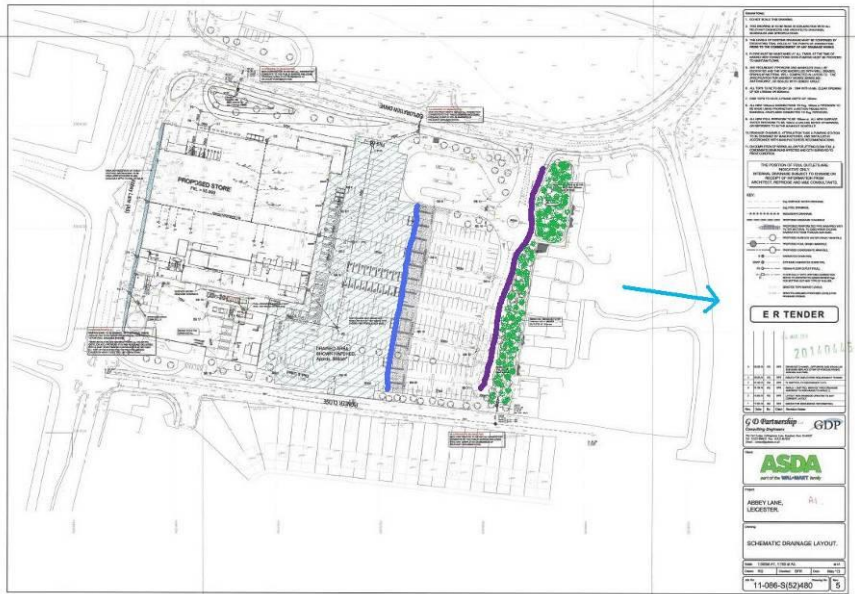

Figure 2 Annotated SuDS plan of the site with drains (blue and purple) and swale (green) highlighted. The blue arrow points to the general location of the River Soar



Figure 3 Images of the completed site

Case Study - Barkbythorpe housing, an example of a lost opportunity

This site on the edge of Leicester is close to the Melton Brook. Despite efforts during the development application stages for incorporation of sustainable drainage, the final pipe to pond solution does not provide the same benefits. The one large open space is a retention pond and is thus railed having four large engineering headwall structures within it. There is no water quality improvement and the space is not available to local children, who end up playing on the roads instead.

Ideally the site would have been analysed for what it could contribute/manage and then designed accordingly. Suggestions such as permeable paved driveways or even small improvements including slight lowering of all soft areas to act as temporary detention and some infiltration were rejected. Some small gains were secured through compensatory works to the nearby Brook, however earlier engagement from the developer may have enabled more beneficial and cost-effective features to be designed into the plans.



Case Study - Grangewood Manor, Leicestershire

On a difficult site, the developer worked closely with the County Council to develop a sustainable drainage approach. Incorporating features such as permeable paving and swales actually led to a cost-saving over more 'traditional' drainage solutions.

http://www.susdrain.org/files/resources/Presentations/steven_clark_chris_leesone14500.pdf

Grangewood Manor Leicestershire

Traditional v SuDS
Cost savings for whole scheme;
almost £100,000; saving £660 per house

Sustainable drainage

http://www.susdrain.org/files/resources/Presentations/steven_clark_chris_leesone14500.pdf

Multi functional

Some of the big guys

Leicester City Council

Case Study - Hucknall Town Centre Improvement Scheme

The proposal centred around construction of a new road which would enable pedestrianisation of the town centre. The initial plan was informed through EIA, however a further assessment was carried out in order to consider the potential impact on WFD objectives as extensive culverting of the Brook was proposed. This took the form of a WFD assessment including whether the ecological status of the Brook was reduced as a result of culverting, the local/wider effects of culverting the Brook, any loss of future opportunities to remove culverts constraining the Brook and provision for habitat improvements elsewhere to compensate for the loss of a naturalised river channel. The WFD assessment was instrumental in altering the design and securing mitigation measures that will improve aquatic habitats.

As an example, the total length of new culverts proposed has been reduced from 107m to 86 m with the creation of new open channel habitats. The overall scheme has also been able to incorporate enough storage to function as a flood relief scheme to parts of the town centre.



Figure 1 Example of original design with proposed culverting

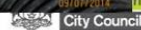
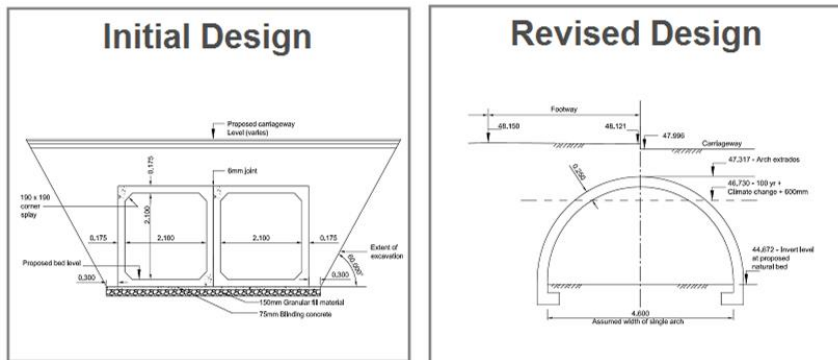

Figure 2 Extract from revised design with reduced culverting and channel modifications

Case Study - Nottingham Ring Road Major Improvement Scheme

The redesign of a major road junction in Nottingham involved widening the carriageway, and extending a length of culvert carrying the Day Brook beneath Hucknall Road, thus resulting in a loss of open channel. In order to reduce the impact of the proposals on the WFD status of the Day Brook, the design of the culvert extension was changed to an arch so that the bed of the river channel was maintained, allowing the upwelling of groundwater and an improved habitat compared to the box culvert option. In recognition of the culvert extension, riparian improvements were undertaken upstream of the culvert, which involved improving the habitats on the bank of the Brook and creating a small wetland area.

The consultations that were undertaken during the funding and planning stages of the project did not identify the need to consider alternative designs for the culvert extension and the need for a WFD assessment was only highlighted at the time of submitting the consent application. Had WFD been considered from the early stages of the project, the funding application could have included an improved solution for the Day Brook, such as removing a length of culvert or restoring a canalised section of the watercourse as part of the scheme.



Case Study - Durlston Centre Pond

Durlston is a busy country park and National Nature Reserve on the Purbeck coast attracting nearly 300,000 visitors per year.

The Centre Pond was created by Friends of Durlston volunteers (who also provided funding for the project) as part of a new Wildlife Area on waste ground adjacent to the Learning Centre. Rather than rainwater from the Centre roof being piped off site in a conventional drainage system, it is instead harvested, and this water can be piped directly into the pond or stored in water butts for future use. This is a great example of a retrofit SuDS which has been implemented to decrease overall site runoff, mitigate flood risk and provide a new wildlife-rich area.

Although a relatively straightforward project, the pond provided a wide range of opportunities for volunteer training, biodiversity enhancement, education and interpretation, public enjoyment and demonstrating best practice.

The area has been colonised by a wide range of wetland species and has proved a magnet for resident and migrant birds. There is no public access onto the site but a specially constructed hide enables educational parties and other visitors to enjoy some spectacular wildlife at close quarters and, at the same time, gain a greater understanding of water conservation issues.



Case Study - River Piddle Trackways Project

A number of farm tracks in Dorset have been identified as contributing large volumes of sediment into local rivers. Such sediment can smother trout and salmon spawning beds, and has a generally detrimental effect of the river's ecology. To tackle the problem, Catchment Sensitive Farming has been working closely with the Environment Agency, and Dorset County Council to improve the surfacing and drainage of selected farm tracks in the Poole Harbour catchment area.

Having identified and secured funding to address the problem, capital work has been undertaken on some 22km of tracks and bridleways in 20 locations across the catchment. This work will slow the pathway for sediment which, in turn, will help to improve rivers in less favourable condition, contribute to the Water Framework Directive and meet targets in the Salmon Action Plan.

One of the first tracks to be completed was Southcombe track near Piddletrenthide in the Piddle valley. This trackway was in a particularly poor condition, causing significant sediment run-off into the river but, following carefully specified resurfacing and drainage work carried out by Dorset County Council, the problem has been greatly reduced. This project is a good example of what can be achieved by local authority countryside and highway services working in close partnership with other organisations to deliver a range of benefits.

Such projects, which have been well supported by farmers, anglers and local community groups, provide long term solutions to what have been very challenging issues. The work also provides a good example of how a practical outcome can contribute to the overall Catchment Based Approach, and help deliver key elements of the Water Framework Directive.

Making Tracks in the Piddle Valley



Stopping the Source & Blocking the Pathways



Appendix B

WFDa Validation Checklist

Planning Checklist

- Is there a water body located within the red line?
 - ✓ If yes WFD will apply.
- Is there a water body within the vicinity of the site – say up to 2km radius?
 - ✓ If yes WFD may apply
- Does the site currently drain to the public sewerage system?

If no where does the site drain to and is there a direct outlet to a water body within the site or 2 km radius-

 - ✓ If yes WFD will apply
- Check details on water body – does it require improvement under WFD?
 - ✓ If yes, what improvement is necessary e.g. physical structures or water quality?
- What improvements could be proposed?
 - Would the works meet WFD objectives in full or in part?
 - Do these include that noted in the mitigation measures?
- How do proposals impact on other constraints such as flood risk
- Can other proposals contribute to the needed improvement under WFD e.g. habitat creation under conservation legislation?
 - How could these be incorporated?
- Is there an existing or potential pollution risk from the site/proposal?
- Will works to reduce potential pollution risk contribute to WFD objectives?
- What weight can be allocated to proposals to achieve WFD objectives?
 - Are there other overriding matters?
- Can the application be modified to allow WFD objectives to be met?
- Can works be subject to s106?
- Can works be conditioned?